

ZASTOSOWANIE

Wentylatory przeznaczone do systemów transportu nieagresywnych i niewybuchowych gazów. Typowe zastosowania:

- transport pneumatyczny,
- nadmuch w układach suszenia (np. maszyny graficzne, obróbka tworzyw sztucznych),
- systemy nadmuchu powietrza w układach spalania/obróbki termicznej (np. piece topialne),
- transport powietrza w instalacjach wentylacyjnych i liniach technologicznych.

KONSTRUKCJA

- niskociśnieniowy, jednostronnie ssący wentylator promieniowy o napędzie bezpośrednim,
- wirniki spawane z czarnej blachy stalowej, jednopowłokowe łopatki zagięte do tyłu, spawane z blachy ze stali węglowej, malowane farbą podkładową, wyważane zgodnie z ISO1940-1,
- obudowy spawane z blachy ze stali węglowej,
- wentylatory standardowo malowane w kolorze niebieskim RAL5010 w klasie korozyjności C3,
- transport medium w zakresie temperatur -20°C do $+80^{\circ}\text{C}$,
- figura standardowa LG270.

SILNIK ELEKTRYCZNY

- asynchroniczny 3-fazowy 230/400V, 50Hz (o mocy do 3.0kW),
- asynchroniczny 3-fazowy 400/690V, 50Hz (o mocy od 4.0kW),
- klasa sprawności IE3,
- stopień ochrony IP55,
- klasa izolacji F,
- przystosowany do regulacji częstotliwościowej,
- temperatura otoczenia silnika od -20°C do $+40^{\circ}\text{C}$.

WYKONANIA SPECJALNE (wymaga uzgodnień)

- dowolna figura LG lub RD,
- malowanie na inny kolor niż standardowy wg palety RAL,
- malowanie w wyższej klasie korozyjności,
- obudowa i wirnik galwanizowane,
- obudowa i wirnik ze stali nierdzewnej 1.4301,
- obudowa i wirnik ze stali kwasoodpornej 1.4404,
- do transportu medium o temperaturze poniżej -20°C i powyżej $+80^{\circ}\text{C}$,
- do pracy w przestrzeniach zagrożenia wybuchem w strefie 1 lub 21 lub 2 lub 22,
- z napędem sprzęgłowym,
- z napędem pasowym,
- z izolacją termiczną i akustyczną,
- z silnikiem na inne niż standardowe napięcie lub częstotliwość zasilania,
- z silnikiem o innym stopniu ochrony IP,
- z silnikiem o innej klasie izolacji,
- z silnikiem wyposażonym w czujniki lub dodatkowe chłodzenie,
- temperatura otoczenia silnika poniżej -20°C i powyżej $+40^{\circ}\text{C}$.

AKCESORIA

- złącza przeciwdrganiowe na wlocie i wylocie,
- rama nośna,
- osłony wlotu i wylotu,
- króćce, redukcje, przejściówki,
- wloty kolanowe,
- wibroizolatory.



FIGURY

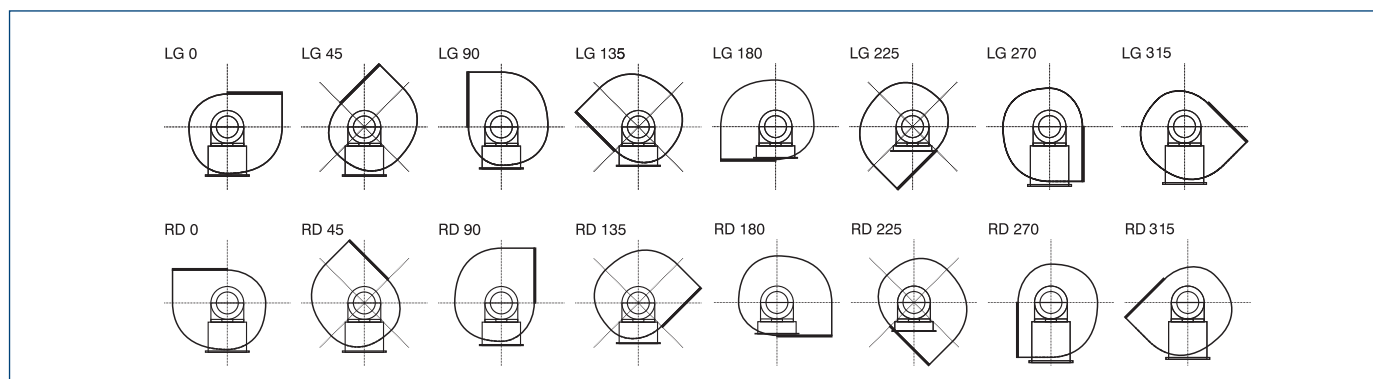

DANE TECHNICZNE

Typ	wydajność max	ciśnienie max	moc silnika	prędkość obrotowa	natężenie	napięcie	poziom ciśnienia akust.*	masa	regulator	nr artykułu
	[m³/h]	[Pa]	[kW]	[obr/min]	[A]	[V]	[dB(A)]	[kg]		
SILNIKI 2-BIEGUNOWE										
BN-2-355-220T	6700	1700	2,2	2910	4,3	230/400	74	65	Falownik 2,2kW	438400220
BN-2-400-400T	10200	2250	4,0	2925	7,4	400/690	77	97	Falownik 4,0kW	438400380
BN-2-450-750T	14200	2850	7,5	2940	13,3	400/690	81	145	Falownik 7,5kW	438400540
BN-2-500-1500T	19450	3400	15,0	2945	26,2	400/690	85	255	Falownik 15kW	438400700
SILNIKI 4-BIEGUNOWE										
BN-4-450-110T	7070	710	1,1	1450	2,5	400/690	68	100	Falownik 1,5kW	438401980
BN-4-500-150T	9700	850	1,5	1450	3,3	400/690	71	145	Falownik 1,5kW	428402140
BN-4-560-300T	13650	1100	3,0	1465	6,3	400/690	75	180	Falownik 4,0kW	438402300
BN-4-630-550T	19450	1400	5,5	1465	10,4	400/690	78	245	Falownik 5,5kW	438402460
BN-4-710-1100T	27740	1770	11,0	1460	20,9	400/690	82	355	Falownik 11kW	438402620
BN-4-800-1850T	39600	2250	18,5	1475	33,9	400/690	86	540	Falownik 18,5kW	438402780
BN-4-900-3000T	56340	2840	30,0	1477	52	400/690	89	785	Falownik 30kW	438402940
BN-4-1000-5500T	77450	3470	55,0	1487	93	400/690	91	1100	Falownik 55kW	438403100
SILNIKI 6-BIEGUNOWE										
BN-6-630-150T	12919	615	1,5	960	3,5	400/690	69	205	Falownik 1,5kW	438404540
BN-6-710-300T	18429	781	3,0	965	6,2	400/690	72	300	Falownik 4,0kW	438404700
BN-6-800-550T	26307	992	5,5	960	11,1	400/690	76	415	Falownik 5,5kW	438404860
BN-6-900-1100T	37432	1254	11,0	970	21,4	400/690	79	600	Falownik 11kW	438405020
BN-6-1000-1500T	51806	1549	15,0	980	29,3	400/690	86	765	Falownik 15kW	438405180
BN-6-1120-3000T	72686	1945	30,0	989	56	400/690	90	1080	Falownik 30kW	438405340
BN-6-1250-4500T	100904	2422	45,0	993	89	400/690	90	1460	Falownik 45kW	438405500

* poziom ciśnienia akustycznego w odległości 3m od wentylatora w 2/3 wydajności maksymalnej

CHARAKTERYSTYKI PRACY

- p_s - ciśnienie całkowite
- p_d - ciśnienie dynamiczne
- pobór mocy

ErP

MC	Kategoria pomiarowa
EC	Kategoria sprawności
VSD	Regulacja prędkości
SR	Ilość biegów
η [%]	Sprawność
N	Współczynnik sprawności
[kW]	Pobór mocy
[m³/h]	Wydajność
[Pa]	Ciśnienie statyczne/całkowite
[RPM]	Prędkość obrotowa

Na podstawie Rozporządzenia Komisji (UE) nr 327/2011 z dnia 30 marca 2011r.

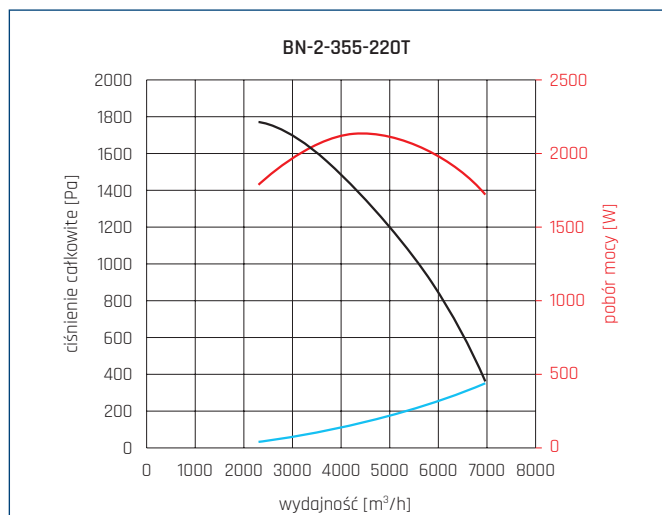

MC	EC	VSD	SR	η [%]	N	[kW]	[m³/h]	[Pa]	[RPM]
B	Całkowita	Nie	1	67,3	73,7	2,5	6960	352	2985

CHARAKTERYSTYKI PRACY

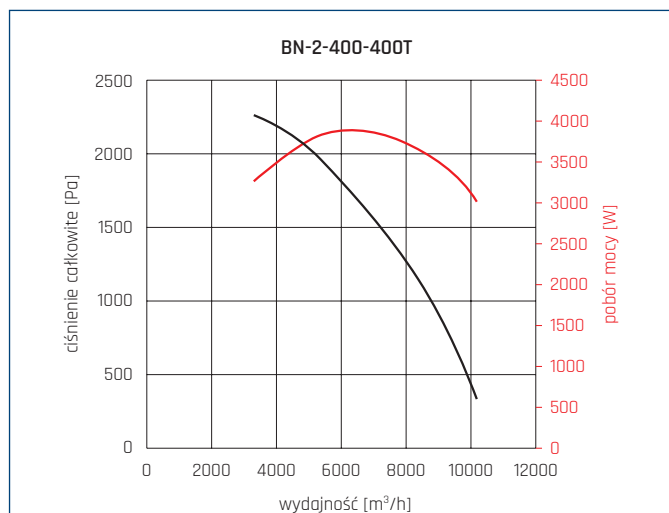

MC	EC	VSD	SR	η[%]	N	[kW]	[m³/h]	[Pa]	[RPM]
B	Całkowita	Nie	1	69,5	73,3	4,3	10159	2253	2985

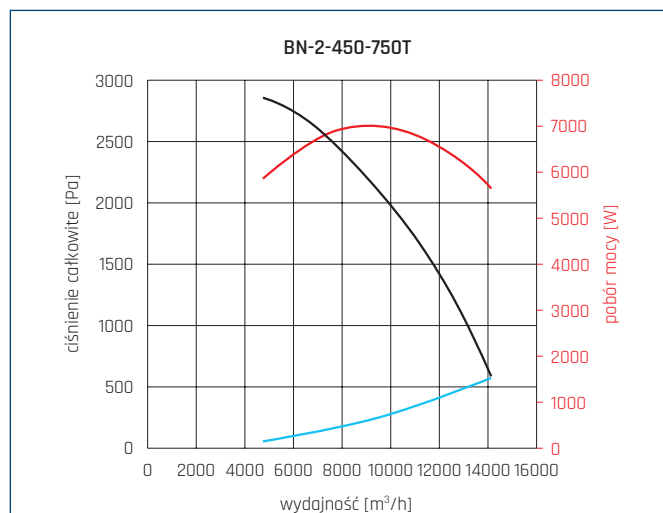

MC	EC	VSD	SR	η[%]	N	[kW]	[m³/h]	[Pa]	[RPM]
B	Całkowita	Nie	1	70,8	72	7,7	14156	2849	2985

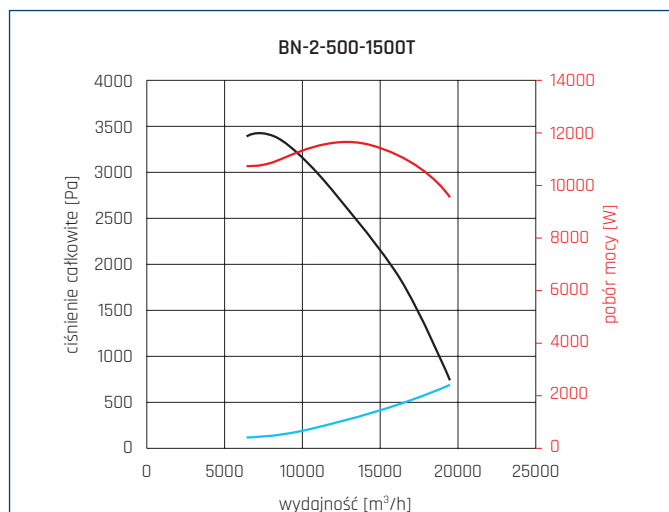

MC	EC	VSD	SR	η[%]	N	[kW]	[m³/h]	[Pa]	[RPM]
B	Całkowita	Nie	1	72,2	72	12,8	19431	3398	2985

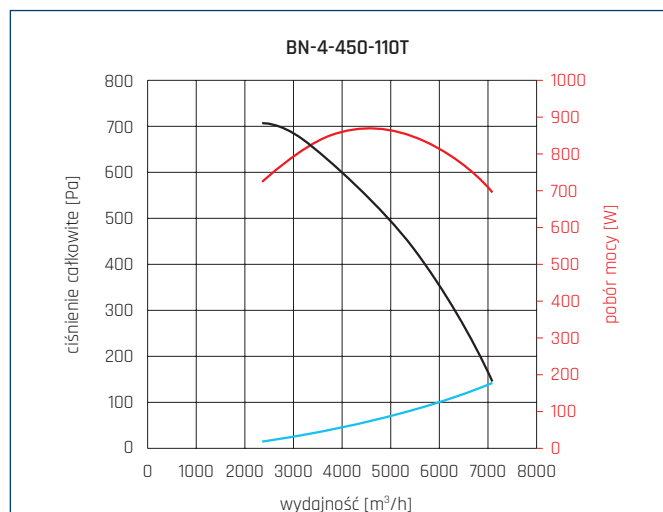

MC	EC	VSD	SR	η[%]	N	[kW]	[m³/h]	[Pa]	[RPM]
B	Całkowita	Nie	1	65,9	71,7	1	7066	710	1490

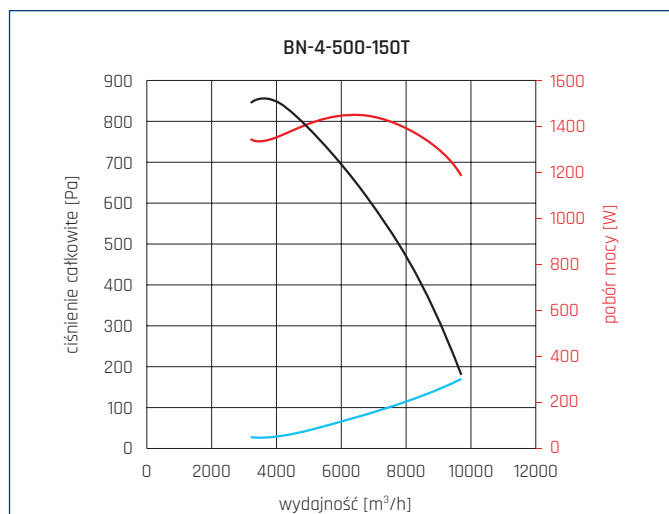

MC	EC	VSD	SR	η[%]	N	[kW]	[m³/h]	[Pa]	[RPM]
B	Całkowita	Nie	1	67,2	75,24	1,7	9699	846	1490

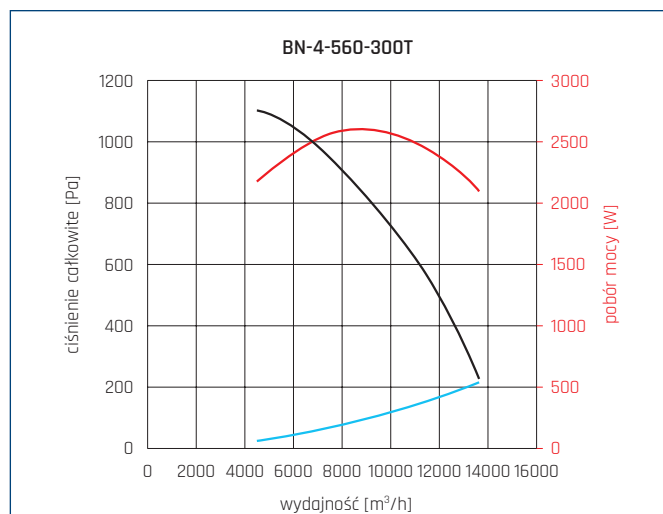

MC	EC	VSD	SR	η[%]	N	[kW]	[m³/h]	[Pa]	[RPM]
B	Całkowita	Nie	1	69,2	74,8	2,9	13646	1100	1490

CHARAKTERYSTYKI PRACY

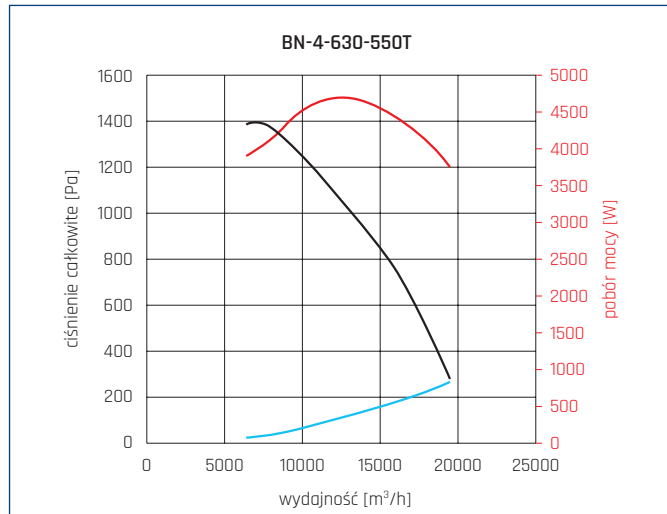

MC	EC	VSD	SR	η[%]	N	[kW]	[m³/h]	[Pa]	[RPM]
B	Całkowita	Nie	1	71	74	5,2	19443	1394	1490

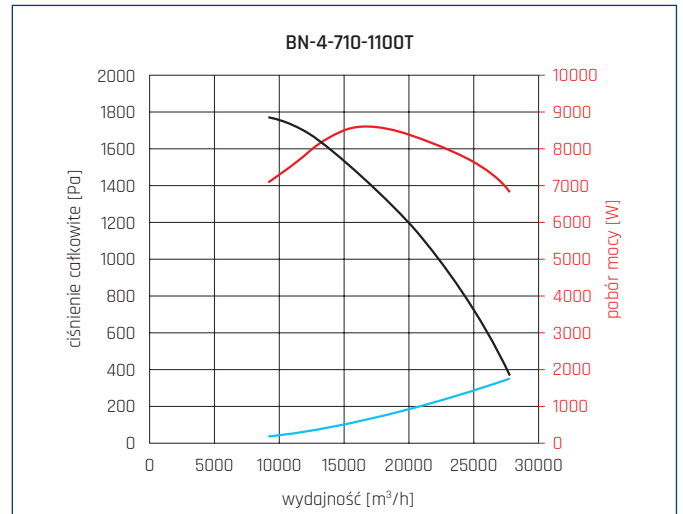

MC	EC	VSD	SR	η[%]	N	[kW]	[m³/h]	[Pa]	[RPM]
B	Całkowita	Nie	1	73,1	73,5	9,2	27736	1770	1490

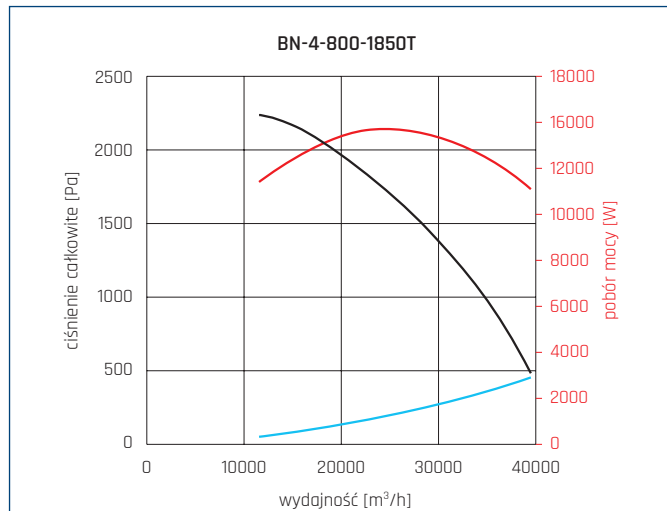

MC	EC	VSD	SR	η[%]	N	[kW]	[m³/h]	[Pa]	[RPM]
B	Całkowita	Nie	1	73,7	73,2	16,6	39594	2247	1490

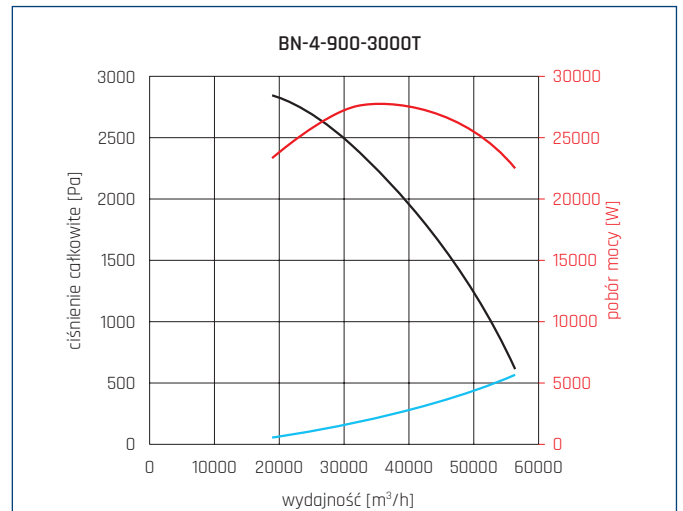

MC	EC	VSD	SR	η[%]	N	[kW]	[m³/h]	[Pa]	[RPM]
B	Całkowita	Nie	1	75,3	74,2	29,3	56337	2840	1490

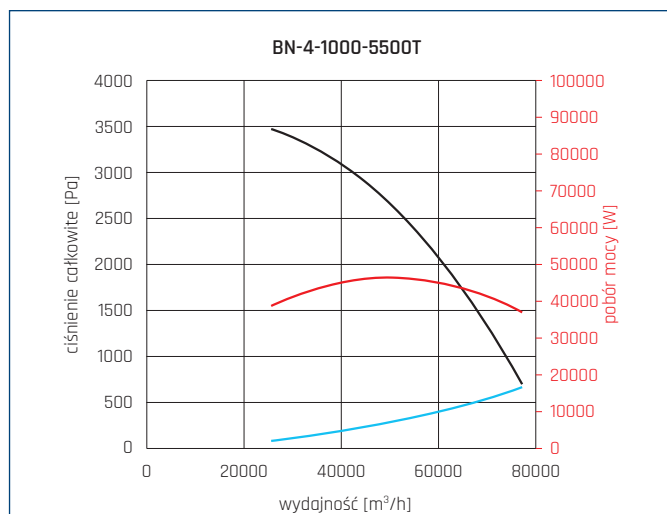

MC	EC	VSD	SR	η[%]	N	[kW]	[m³/h]	[Pa]	[RPM]
B	Całkowita	Nie	1	75,8	74,2	48,5	51883	2533	1480

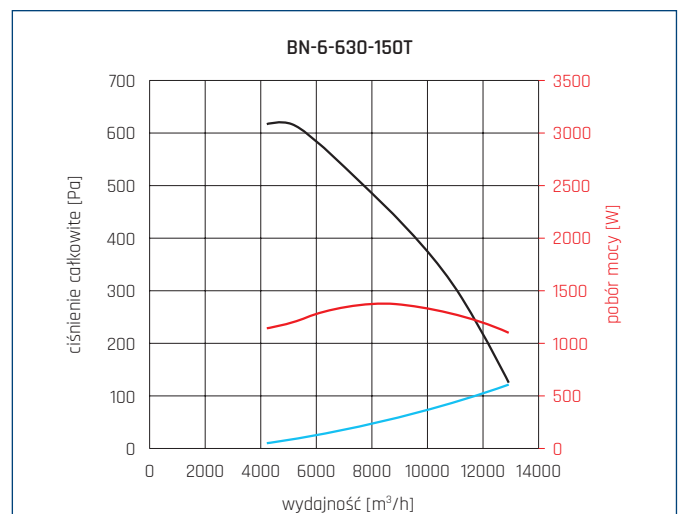

MC	EC	VSD	SR	η[%]	N	[kW]	[m³/h]	[Pa]	[RPM]
B	Całkowita	Nie	1	65,5	73,7	1,64	8971	434	990

CHARAKTERYSTYKI PRACY

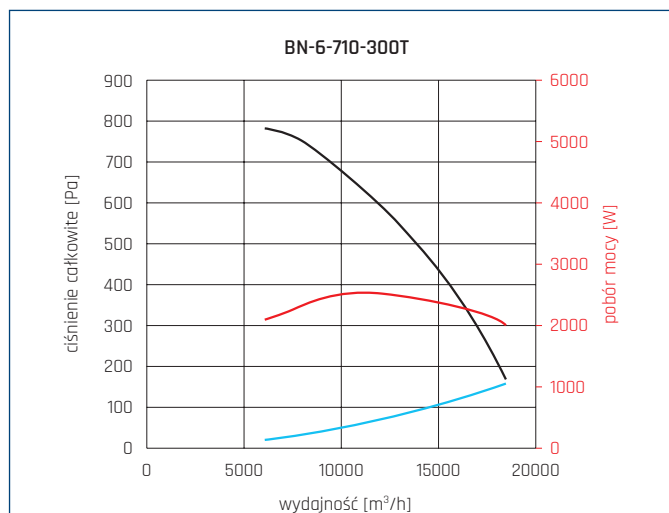

MC	EC	VSD	SR	η[%]	N	[kW]	[m³/h]	[Pa]	[RPM]
B	Całkowita	Nie	1	69,7	75,5	2,8	12883	549	990

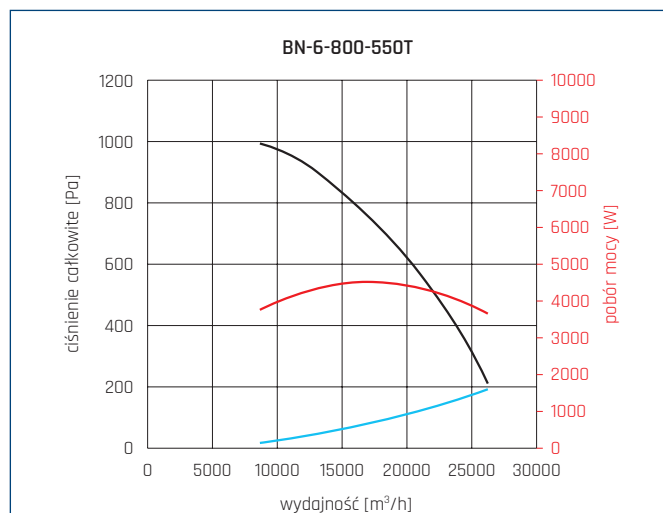

MC	EC	VSD	SR	η[%]	N	[kW]	[m³/h]	[Pa]	[RPM]
B	Całkowita	Nie	1	71	74,1	5,1	18430	697	990

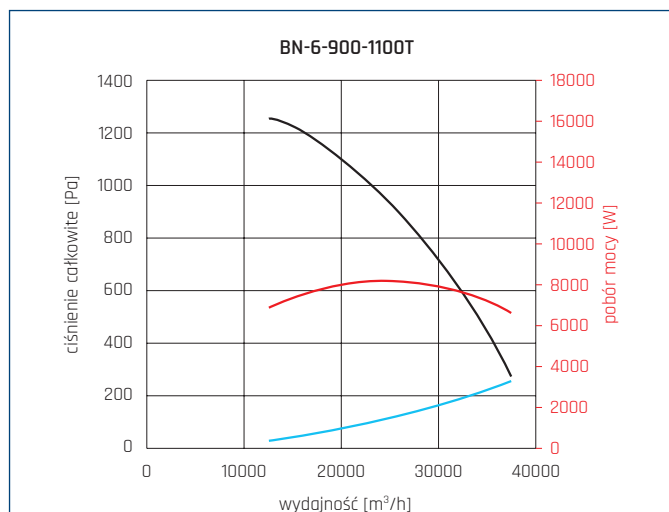

MC	EC	VSD	SR	η[%]	N	[kW]	[m³/h]	[Pa]	[RPM]
B	Całkowita	Nie	1	72,6	73	9,14	26070	890	990

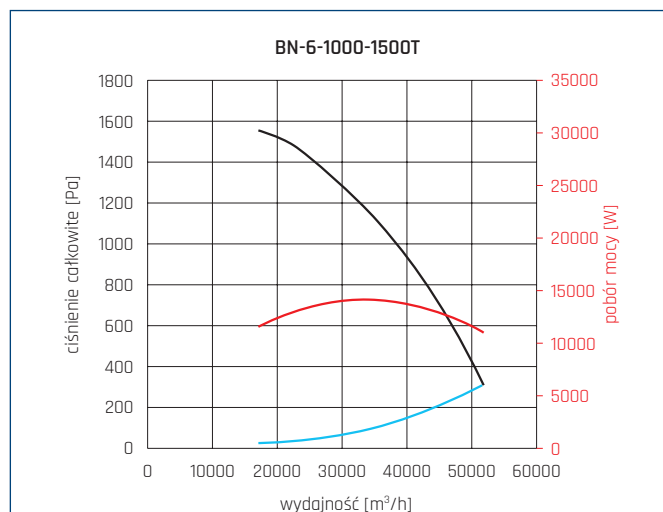

MC	EC	VSD	SR	η[%]	N	[kW]	[m³/h]	[Pa]	[RPM]
B	Całkowita	Nie	1	73,3	72,9	15,12	35680	1101	990

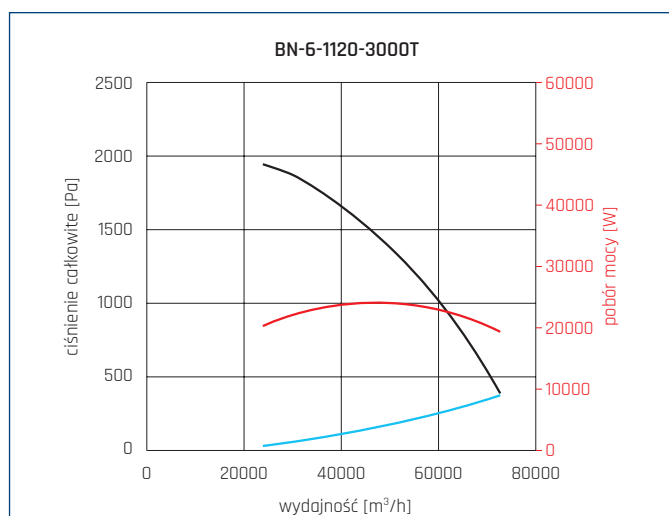

MC	EC	VSD	SR	η[%]	N	[kW]	[m³/h]	[Pa]	[RPM]
B	Całkowita	Nie	1	74	73	26,3	50681	1364	990

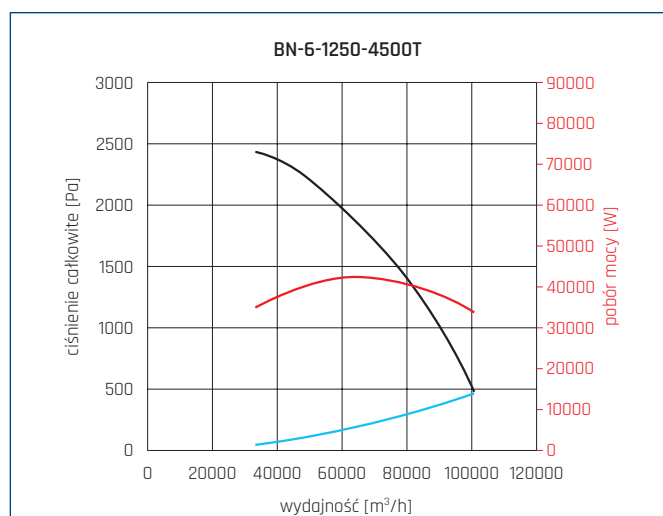

MC	EC	VSD	SR	η[%]	N	[kW]	[m³/h]	[Pa]	[RPM]
B	Całkowita	Nie	1	75,5	73,9	43,9	70706	1691	990

WYMIARY [mm]

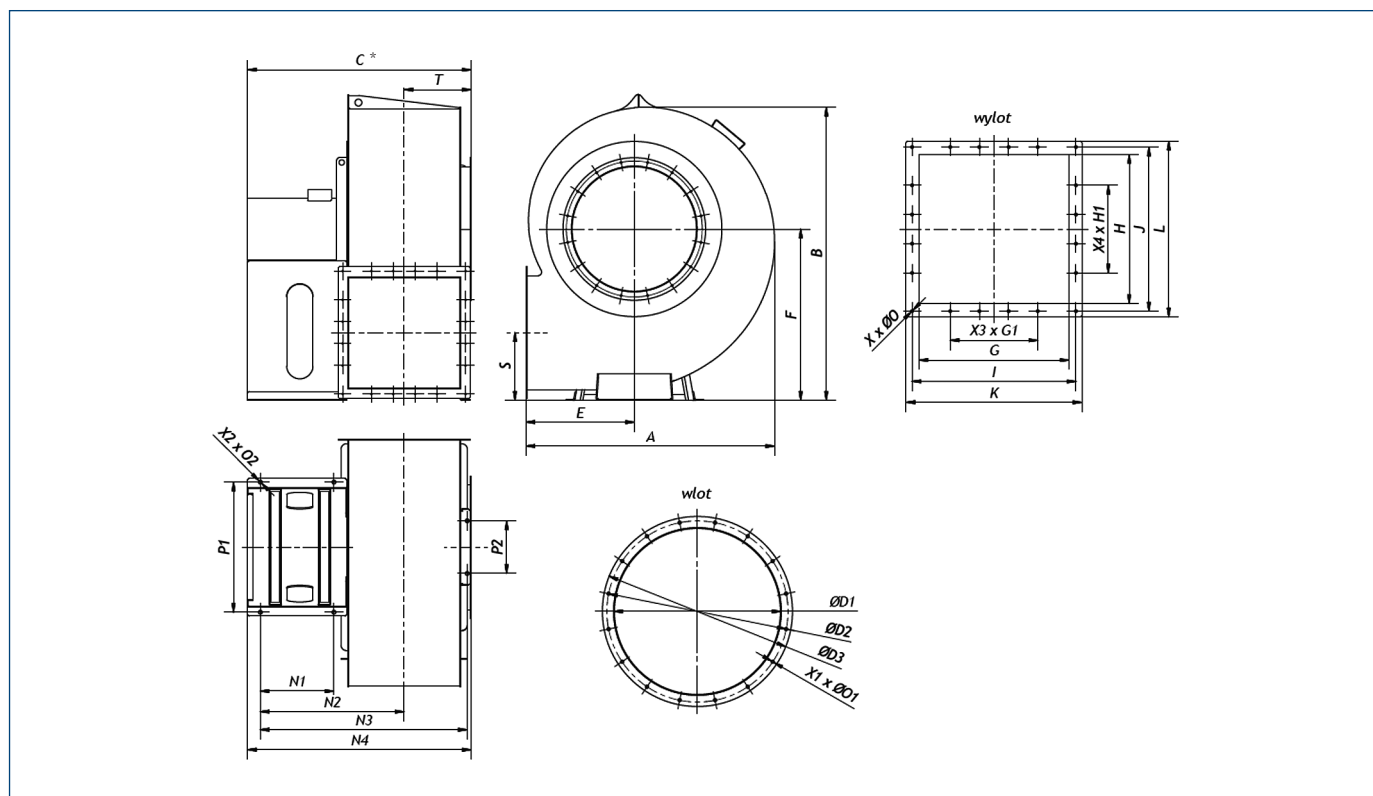

Typ	A	B	C*	E	F	S	T	P1	P2	N1	N2	N3	N4	X2 x Ø2
315	570	701	370	244	430	240	165	350	150	180	137	472	502	6 x Ø11,5
355	642	783	450	275	478	271	178	400	180	180	165	513	558	6 x Ø14
400	723	875	470	309	532	305	194	400	180	220	176	579	620	6 x Ø14
450	815	981	550	349	594	344	222	460	180	240	197	642	689	6 x Ø14
500	917	1097	550	392	662	387	244	500	250	320	226	772	831	6 x Ø17
560	1019	1214	720	436	730	430	266	500	250	370	249	863	925	6 x Ø17
630	1141	1353	915	488	811	481	291	600	250	420	285	974	1046	6 x Ø17
710	1285	1517	1000	550	907	542	316	600	250	420	310	1024	1096	6 x Ø17
800	1447	1702	850	619	1015	610	346	670	250	380	350	1054	1136	6 x Ø17
900	1631	1912	900	698	1138	688	382	743	300	420	401	1181	1278	6 x Ø22
1000	1835	2145	1000	785	1274	774	423	743	300	420	441	1261	1359	6 x Ø22
1120	2039	2378	1100	873	1410	860	468	743	300	420	486	1351	1449	6 x Ø22
1250	2283	2657	1240	977	1573	963	518	900	300	420	536	1451	1549	6 x Ø22
1400	2549	2960	1400	1091	1750	1075	568	950	400	450	586	1550	1718	6 x Ø22
1600	2855	3309	1600	1222	1954	1204	610	1150	400	450	626	1650	1860	6 x Ø22

Typ	L	J	H	X4 x H1	K	I	G	X3 x G1	X x Ø	ØD1	ØD2	ØD3	X1 x Ø1
315	362	326	282	-	286	260	224	-	8xØ12	283	332	363	8xØ11,5
355	397	361	317	1x125	312	286	250	-	10xØ12	318	366	398	8xØ11,5
400	437	401	357	1x125	362	326	280	-	10xØ12	358	405	438	8xØ11,5
450	482	446	402	1x125	397	361	315	1x125	12xØ12	404	448	484	12xØ11,5
500	532	496	452	3x125	437	401	355	1x125	16xØ12	454	497	534	12xØ11,5
560	582	546	502	3x125	482	446	400	1x125	16xØ12	504	551	584	12xØ11,5
630	642	606	562	3x125	532	496	450	3x125	20xØ12	564	629	664	16xØ14
710	752	702	630	3x125	582	546	500	3x125	20xØ12	634	698	734	16xØ14
800	832	782	710	5x125	642	606	560	3x125	24xØ12	714	775	814	16xØ14
900	922	872	800	5x125	752	702	630	3x125	24xØ12	804	861	904	24xØ14
1000	1022	972	900	5x125	832	782	710	5x125	28xØ12	904	958	1004	24xØ14
1120	1122	1072	1000	7x125	922	872	800	5x125	32xØ12	1005	1067	1105	24xØ14
1250	1242	1192	1122	7x125	1022	972	900	5x125	32xØ12	1125	1200	1245	32xØ18
1400	1372	1322	1252	9x125	1122	1072	1000	7x125	40xØ12	1255	1337	1375	32xØ18
1600	1522	1472	1402	9x125	1242	1192	1122	7x125	40xØ12	1405	1525	1475	32xØ18

* -wymiar zależny od rodzaju silnika.

AKCESORIA MONTAŻOWE

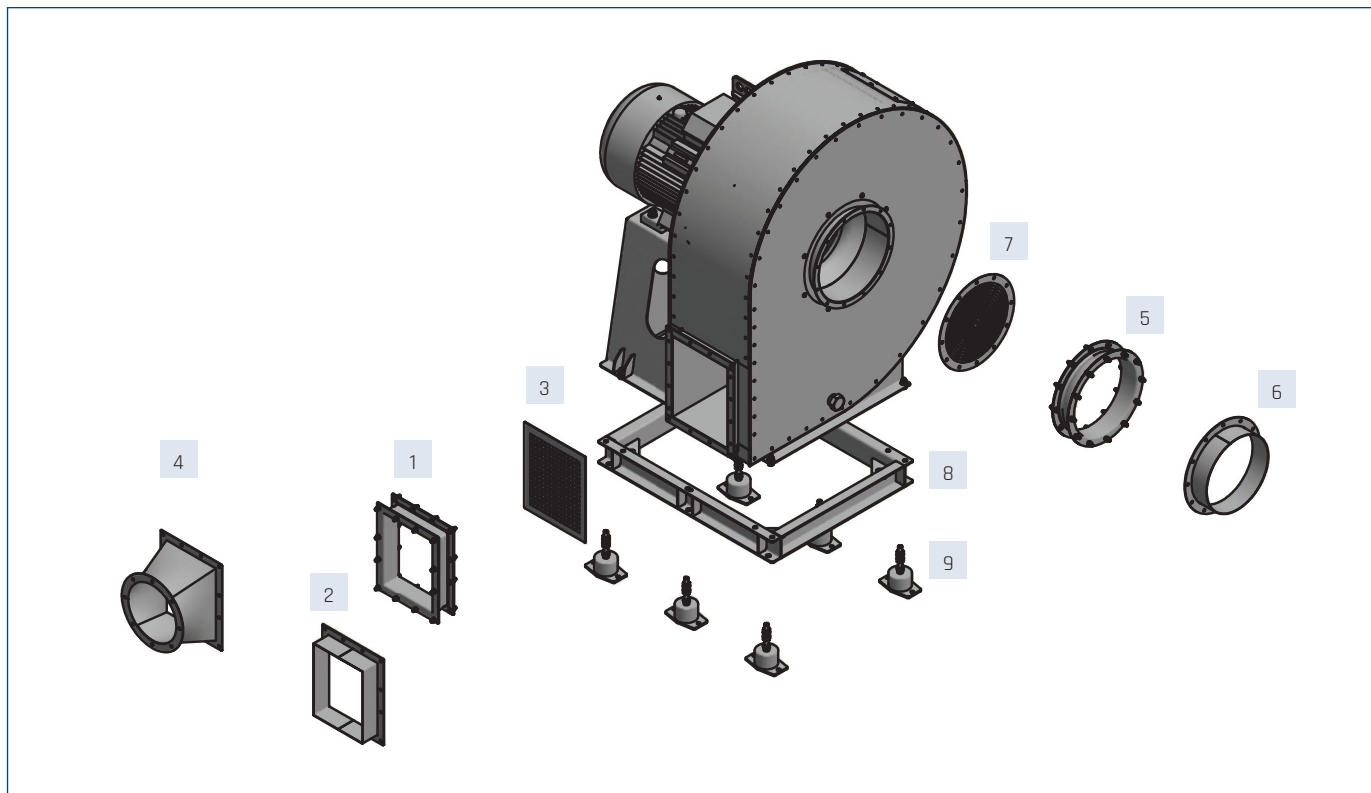

Wentylator	Wylot				Wlot			8
	1	2	3	4	5	6	7	
	Złącze przeciwdrganiowe	Króciec prosty	Ośłona wylotu	Przejściówka	Złącze przeciwdrganiowe	Króciec prosty	Ośłona wlotu	
BN315	40549100	40549500	40549300	40549700	40545140	40545340	40545540	40545700
BN355	40549110	40549510	40549310	40549710	40545150	40545350	40545550	40545710
BN400	40549120	40549520	40549320	40549720	40545160	40545360	40545560	40545720
BN450	40549130	40549530	40549330	40549730	40545170	40545370	40545570	40545730
BN500	40549140	40549540	40549340	40549740	40545180	40545380	40545580	40545740
BN560	40549150	40549550	40549350	40549750	40545190	40545390	40545590	40545750
BN630	40549160	40549560	40549360	40549760	40545200	40545400	40545600	40545760
BN710	40549170	40549570	40549370	40549770	40545210	40545410	40545610	40545770
BN800	40549180	40549580	40549380	40549780	40545220	40545420	40545620	40545780
BN900	40549190	40549590	40549390	40549790	40545230	40545430	40545630	40545790
BN1000	40549200	40549600	40549400	40549800	40545240	40545440	40545640	40545800
BN1120	40549210	40549610	40549410	40549810	40545250	40545450	40545650	40545810
BN1250	40549220	40549620	40549420	40549820	40545260	40545460	40545660	40545820

