

## ZASTOSOWANIE

Wentylatory przeznaczone do systemów transportu nieagresywnych i niewybuchowych gazów. Typowe zastosowania:

- transport pneumatyczny,
- nadmuch w układach suszenia (np. maszyny graficzne, obróbka tworzyw sztucznych),
- systemy nadmuchu powietrza w układach spalania/obróbki termicznej (np. piece topialne),
- transport powietrza w instalacjach wentylacyjnych i liniach technologicznych.

## KONSTRUKCJA

- średnicciśnieniowy, jednostronnie ssący wentylator promieniowy o napędzie bezpośrednim,
- wirniki spawane z czarnej blachy stalowej, jednopowłokowe łopaty zagięte do tyłu, spawane z blachy ze stali węglowej, malowane farbą podkładową, wyważane zgodnie z ISO1940-1,
- obudowy spawane z blachy ze stali węglowej,
- wentylatory standardowo malowane w kolorze niebieskim RAL5010 w klasie korozyjności C3,
- transport medium w zakresie temperatur  $-20^{\circ}\text{C}$  do  $+80^{\circ}\text{C}$ ,
- figura standardowa LG270.

## SILNIK ELEKTRYCZNY

- asynchroniczny 3-fazowy 230/400V, 50Hz (o mocy do 3.0kW),
- asynchroniczny 3-fazowy 400/690V, 50Hz (o mocy od 4.0kW),
- klasa sprawności IE3,
- stopień ochrony IP55,
- klasa izolacji F,
- przystosowany do regulacji częstotliwościowej,
- temperatura otoczenia silnika od  $-20^{\circ}\text{C}$  do  $+40^{\circ}\text{C}$ .

## WYKONANIA SPECJALNE (wymaga uzgodnień)

- dowolna figura LG lub RD,
- malowanie na inny kolor niż standardowy wg palety RAL,
- malowanie w wyższej klasie korozyjności,
- obudowa i wirnik galwanizowane,
- obudowa i wirnik ze stali nierdzewnej 1.4301,
- obudowa i wirnik ze stali kwasoodpornej 1.4404,
- do transportu medium o temperaturze poniżej  $-20^{\circ}\text{C}$  i powyżej  $+80^{\circ}\text{C}$ ,
- do pracy w przestrzeniach zagrożenia wybuchem w strefie 1 lub 21 lub 2 lub 22,
- z napędem sprzęgłowym,
- z napędem pasowym,
- z izolacją termiczną i akustyczną,
- z silnikiem na inne niż standardowe napięcie lub częstotliwość zasilania,
- z silnikiem o innym stopniu ochrony IP,
- z silnikiem o innej klasie izolacji,
- z silnikiem wyposażonym w czujniki lub dodatkowe chłodzenie,
- temperatura otoczenia silnika poniżej  $-20^{\circ}\text{C}$  i powyżej  $+40^{\circ}\text{C}$ .

## AKCESORIA

- złącza przeciwdrganiowe na wlocie i wylocie,
- rama nośna,
- osłony wlotu i wylotu,
- króćce, redukcje, przejściówki,
- wloty kolanowe,
- wibroizolatory.



## FIGURY

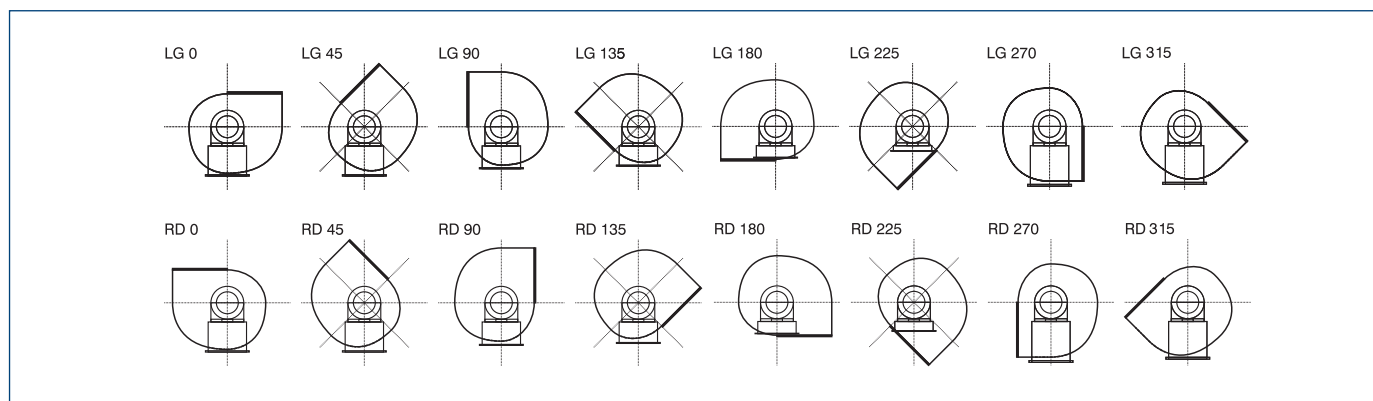

## DANE TECHNICZNE

Typ	wydajność max	ciśnienie max	prędkość obrotowa	napięcie	natężenie	moc silnika	poziom ciśnienia akust.*	masa	nr artykułu
	[m³/h]	[Pa]	[obr/min]	[V]	[A]	[kW]	[dB(A)]	[kg]	
<b>SILNIKI 2-BIEGUNOWE</b>									
BM-2-315-110T	3480	1540	2985	230/400	2,5	1,1	67	44	438100060
BM-2-355-220T	4980	1930	2985	230/400	4,3	2,2	71	64	438100220
BM-2-400-400T	3530	610	2985	400/690	7,4	4	74	96	428100380
BM-2-450-750T	10120	3110	2985	400/690	13,3	7,5	78	145	438100540
BM-2-500-1100T	12500	3380	2985	400/690	19,6	11	81	245	438100700
BM-2-560-1850T	18500	4380	2985	400/690	32,1	18,5	84	285	438100860
BM-2-630-3000T	27830	6090	2985	400/690	51,0	30	88	455	438101020
<b>SILNIKI 4-BIEGUNOWE</b>									
BM-4-315-055T	1730	380	1490	230/400	1,6	0,55	52	40	48101500
BM-4-355-055T	2480	480	1490	230/400	1,6	0,55	56	53	48101660
BM-4-400-110T	1750	150	1490	230/400	2,5	0,55	59	78	48101820
BM-4-450-220T	5050	770	1490	230/400	4,6	0,75	63	108	438101980
BM-4-500-220T	6920	960	1490	230/400	4,6	1,1	66	148	438102140
BM-4-560-220T	9730	1180	1490	230/400	4,6	2,2	69	173	438102300
BM-4-630-400T	13890	1510	1490	400/690	8,1	4,0	73	222	438102460
BM-4-710-750T	19830	1750	1490	400/690	14,4	7,5	76	308	438102620
BM-4-800-1500T	28280	2420	1490	400/690	28,3	15	80	500	438102780
BM-4-900-2200T	40400	3040	1490	400/690	41,1	22	83	650	438102940
<b>SILNIKI 6-BIEGUNOWE</b>									
BM-6-710-220T	13179	849	990	230/400	5,0	2,2	68	275	428104700
BM-6-800-400T	18809	1079	990	400/690	8,1	4	71	408	428104860
BM-6-900-750T	26000	1260	990	400/690	14,8	7,5	75	585	438105020
BM-6-1000-1500T	36822	1701	990	400/690	29,3	15	78	760	438105180
BM-6-1120-2200T	99990	4570	990	400/690	42,0	22	81	990	438105340
BM-6-1250-3700T	71918	2658	990	400/690	70,0	37	85	1260	438105500

\*poziom ciśnienia akustycznego w odległości 3m od wentylatora w 2/3 wydajności maksymalnej

## CHARAKTERYSTYKI PRACY

- $p_s$  - ciśnienie całkowite
- $p_d$  - ciśnienie dynamiczne
- pobór mocy

### ErP

MC	Kategoria pomiarowa
EC	Kategoria sprawności
VSD	Regulacja prędkości
SR	Ilość biegów
$\eta$ [%]	Sprawność
N	Współczynnik sprawności
[kW]	Pobór mocy
[m³/h]	Wydajność
[Pa]	Ciśnienie statyczne/całkowite
[RPM]	Prędkość obrotowa

Na podstawie Rozporządzenia Komisji (UE) nr 327/2011 z dnia 30 marca 2011r.

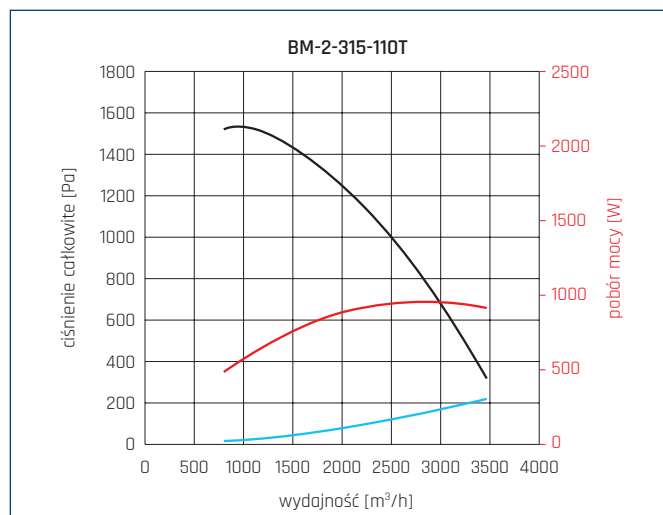

MC	EC	VSD	SR	$\eta$ [%]	N	[kW]	[m³/h]	[Pa]	[RPM]
B	Całkowita	Nie	1	64,2	74,7	1,01	1732	1358	2985

## CHARAKTERYSTYKI PRACY

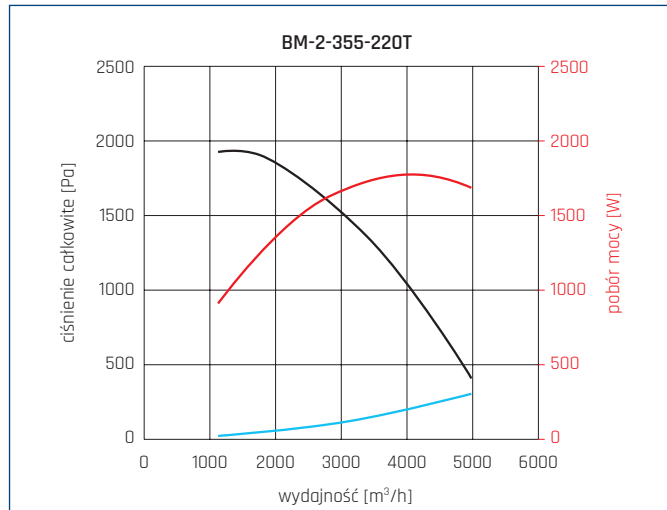

MC	EC	VSD	SR	$\eta$ [%]	N	[kW]	[m³/h]	[Pa]	[RPM]
B	Całkowita	Nie	1	67,2	75,2	1,73	2479	1725	2985

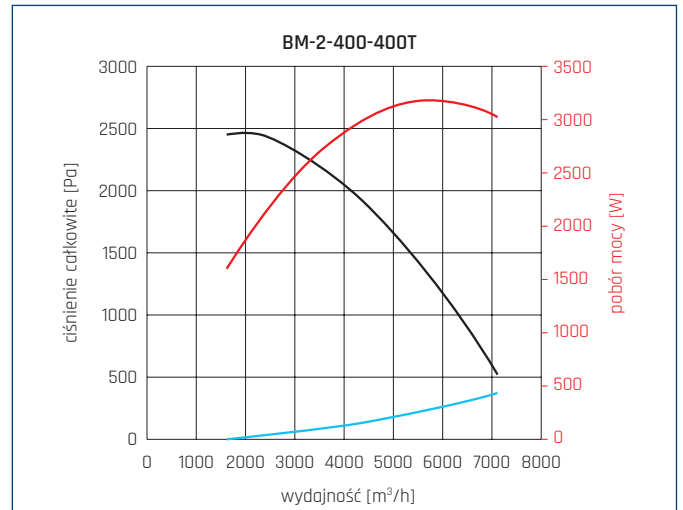

MC	EC	VSD	SR	$\eta$ [%]	N	[kW]	[m³/h]	[Pa]	[RPM]
B	Całkowita	Nie	1	69,3	74,6	3,13	3714	2140	2985

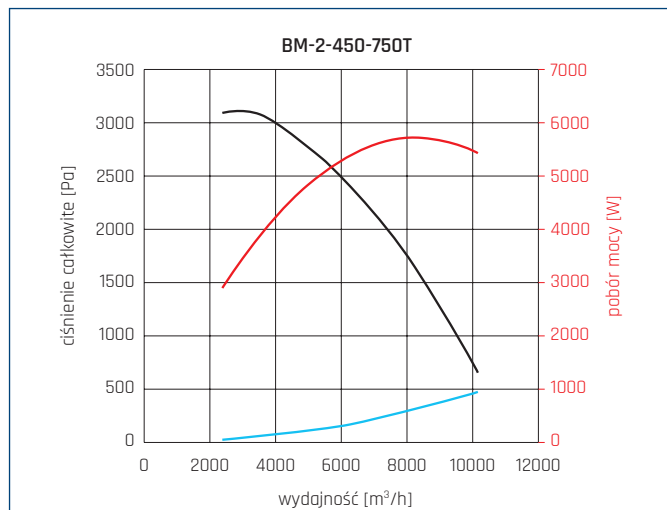

MC	EC	VSD	SR	$\eta$ [%]	N	[kW]	[m³/h]	[Pa]	[RPM]
B	Całkowita	Nie	1	70,6	73,3	5,54	5216	2727	2985

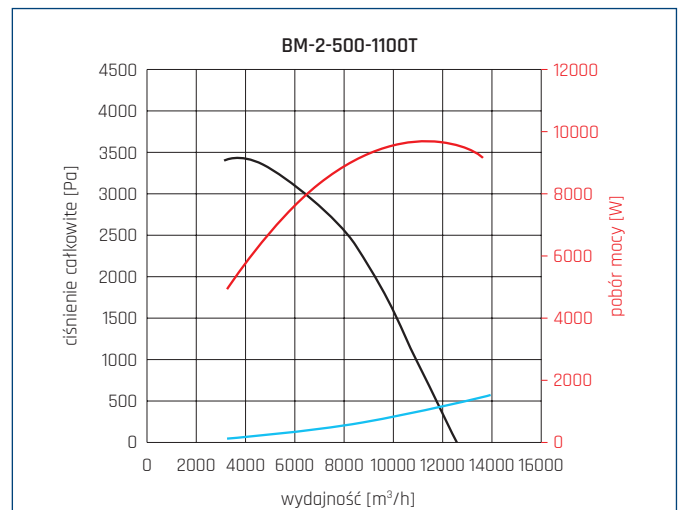

MC	EC	VSD	SR	$\eta$ [%]	N	[kW]	[m³/h]	[Pa]	[RPM]
B	Całkowita	Nie	1	71,8	72,2	9,1	12500	3380	2985

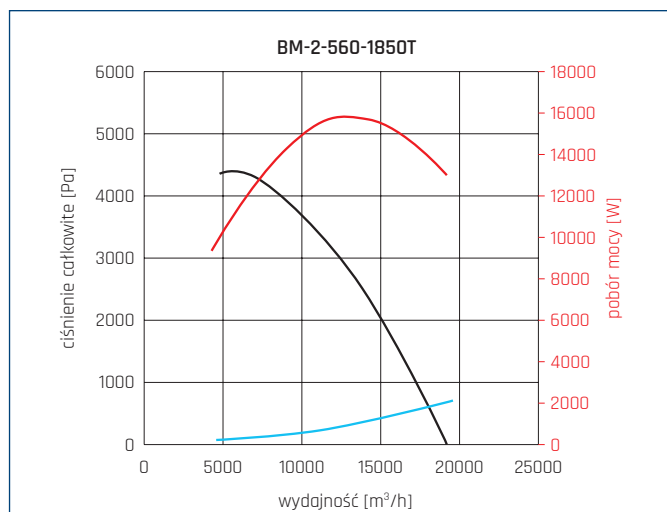

MC	EC	VSD	SR	$\eta$ [%]	N	[kW]	[m³/h]	[Pa]	[RPM]
B	Całkowita	Nie	1	73	72,6	15,84	18500	4380	2985

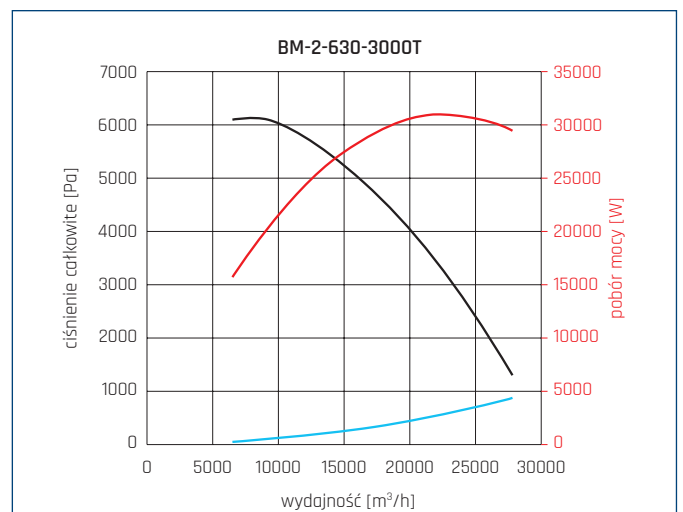

MC	EC	VSD	SR	$\eta$ [%]	N	[kW]	[m³/h]	[Pa]	[RPM]
B	Całkowita	Nie	1	74	72,9	28,5	14115	5385	2985

## CHARAKTERYSTYKI PRACY

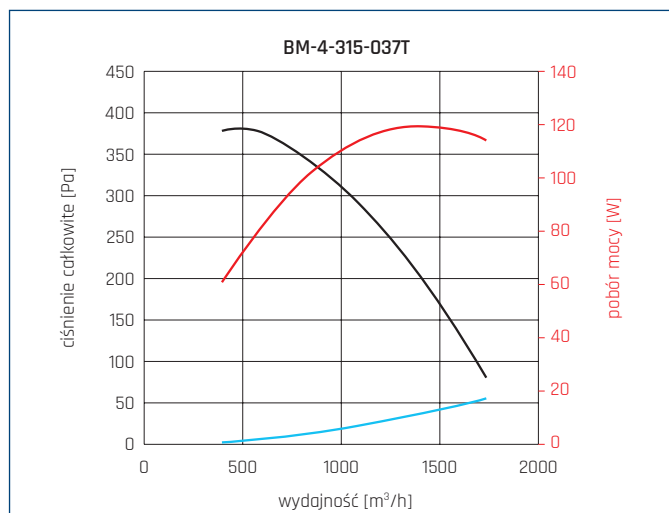

MC	EC	VSD	SR	η[%]	N	[kW]	[m³/h]	[Pa]	[RPM]
B	Całkowita	Nie	1	56,5	73,2	0,26	873	337	1490

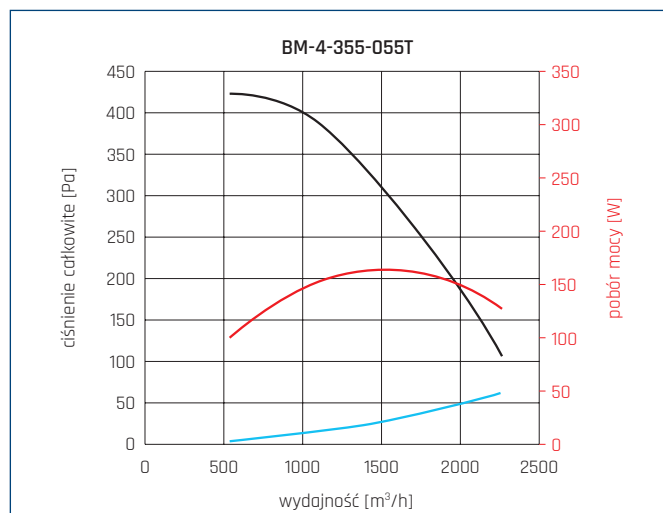

MC	EC	VSD	SR	η[%]	N	[kW]	[m³/h]	[Pa]	[RPM]
B	Całkowita	Nie	1	56,7	73,4	0,26	1249	428	1490

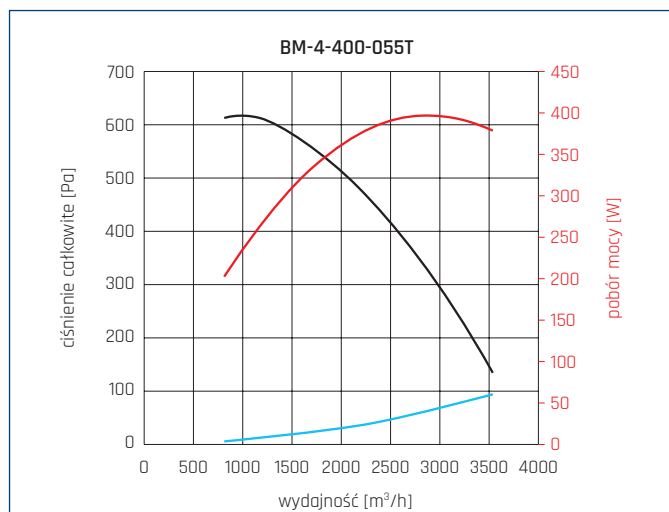

MC	EC	VSD	SR	η[%]	N	[kW]	[m³/h]	[Pa]	[RPM]
B	Całkowita	Nie	1	65,5	80,1	0,42	1829	537	1490

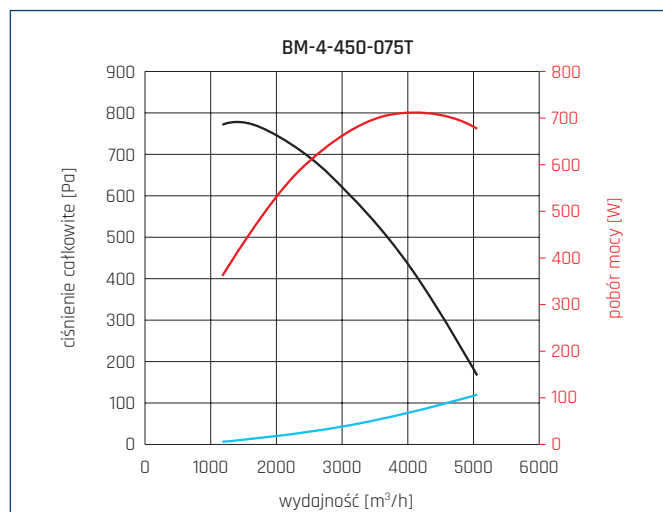

MC	EC	VSD	SR	η[%]	N	[kW]	[m³/h]	[Pa]	[RPM]
B	Całkowita	Nie	1	67,8	79,9	0,72	2615	678	1490

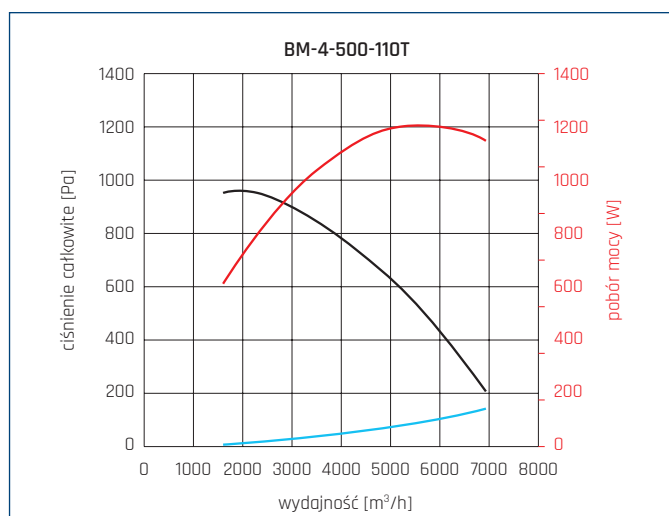

MC	EC	VSD	SR	η[%]	N	[kW]	[m³/h]	[Pa]	[RPM]
B	Całkowita	Nie	1	68,1	77,8	1,2	3457	852	1490

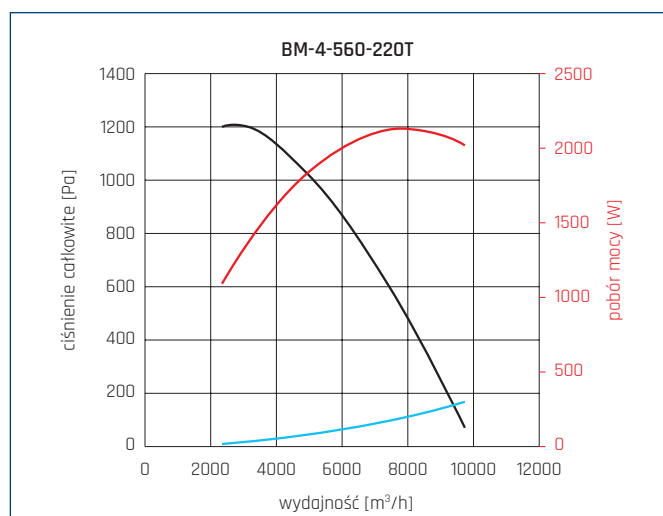

MC	EC	VSD	SR	η[%]	N	[kW]	[m³/h]	[Pa]	[RPM]
B	Całkowita	Nie	1	68,3	75,3	2,14	9730	1180	1490

CHARAKTERYSTYKI PRACY

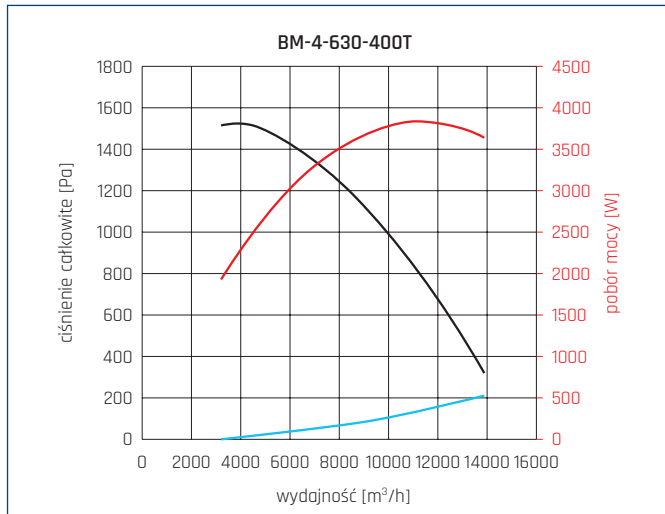

MC	EC	VSD	SR	η[%]	N	[kW]	[m³/h]	[Pa]	[RPM]
B	Całkowita	Nie	1	70	74,6	3,6	7111	1335	1490

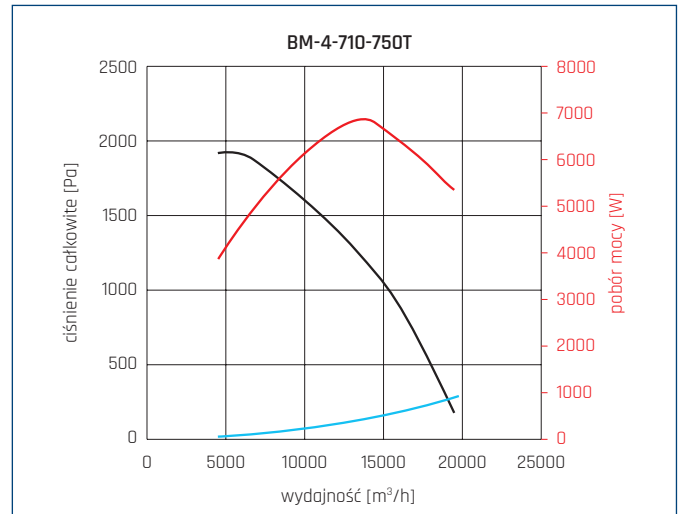

MC	EC	VSD	SR	η[%]	N	[kW]	[m³/h]	[Pa]	[RPM]
B	Całkowita	Nie	1	71,8	73,6	6,7	19830	1750	1490

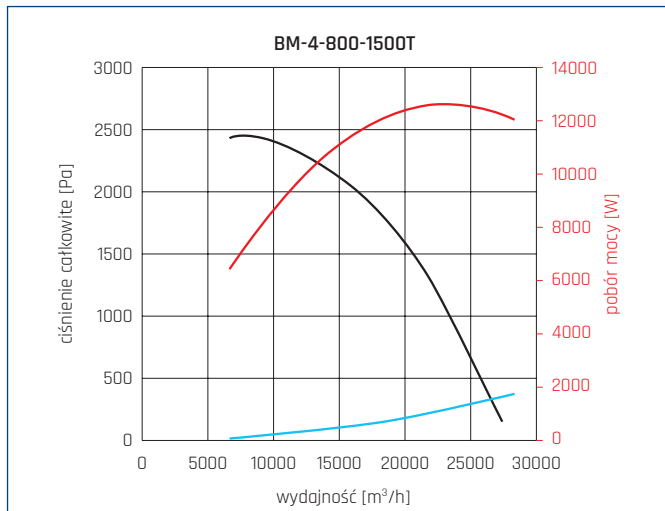

MC	EC	VSD	SR	η[%]	N	[kW]	[m³/h]	[Pa]	[RPM]
B	Całkowita	Nie	1	73,5	73,4	11,8	28280	2420	1490

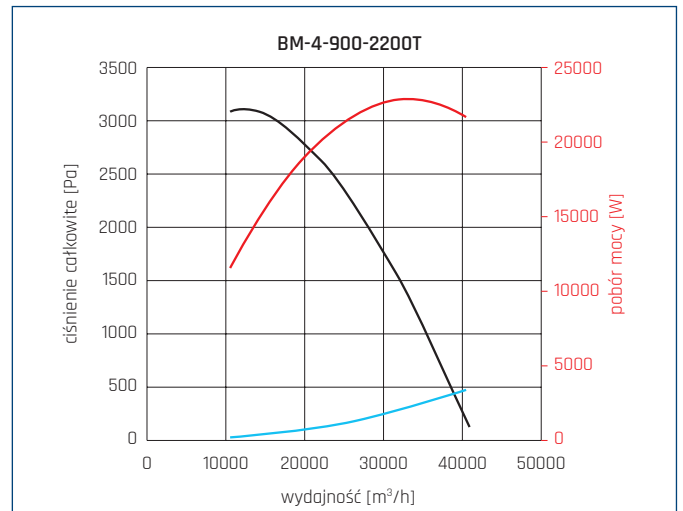

MC	EC	VSD	SR	η[%]	N	[kW]	[m³/h]	[Pa]	[RPM]
B	Całkowita	Nie	1	74,1	73,3	21,3	40400	3040	1490

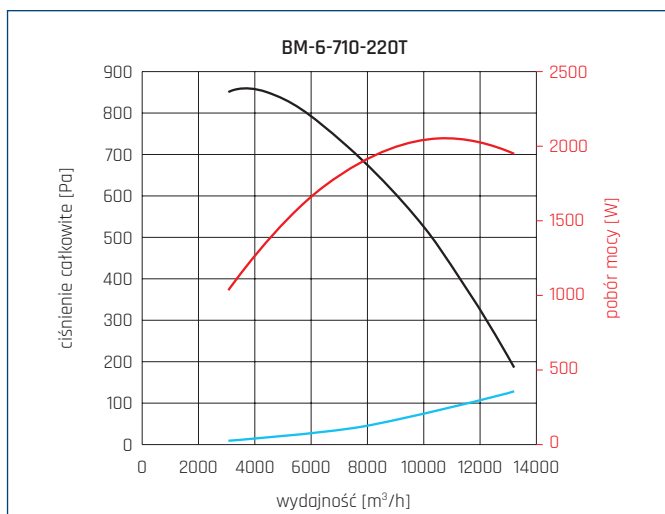

MC	EC	VSD	SR	η[%]	N	[kW]	[m³/h]	[Pa]	[RPM]
B	Całkowita	Nie	1	67,2	74,3	2,1	6794	747	990

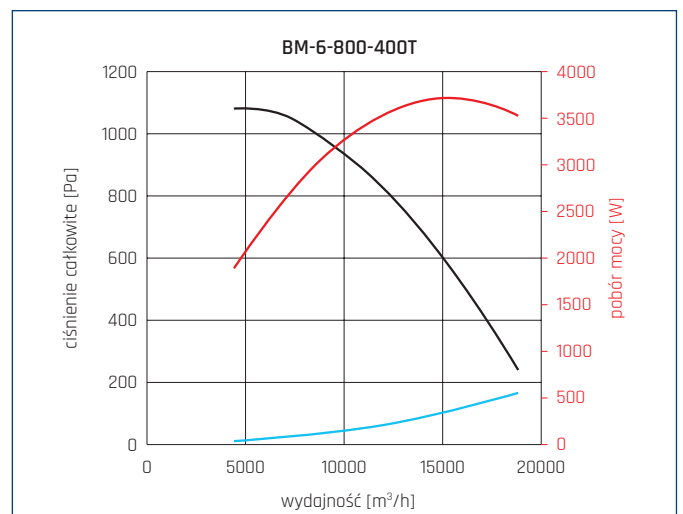

MC	EC	VSD	SR	η[%]	N	[kW]	[m³/h]	[Pa]	[RPM]
B	Całkowita	Nie	1	70,9	75,6	3,6	9541	957	990

CHARAKTERYSTYKI PRACY

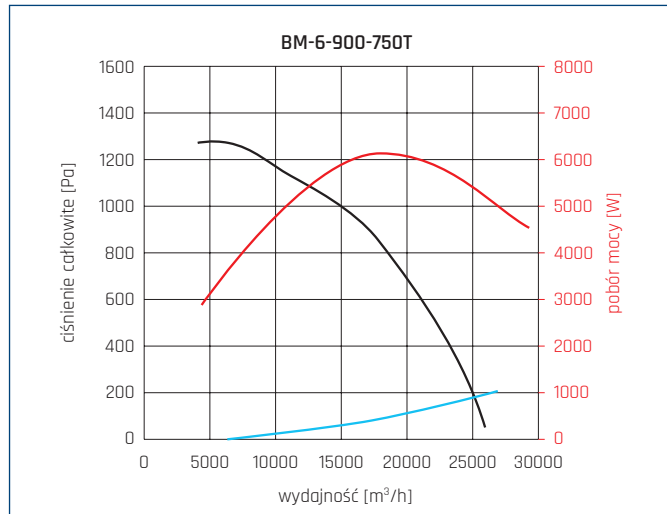

MC	EC	VSD	SR	η[%]	N	[kW]	[m³/h]	[Pa]	[RPM]
B	Całkowita	Nie	1	71,7	73,7	6,47	26000	1260	990

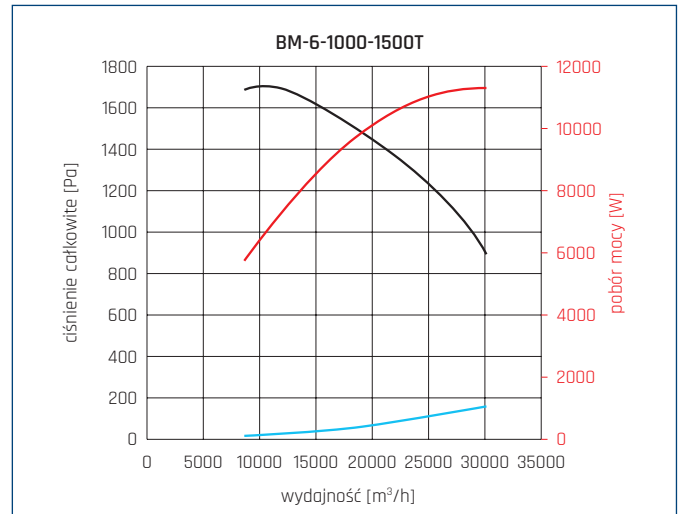

MC	EC	VSD	SR	η[%]	N	[kW]	[m³/h]	[Pa]	[RPM]
B	Całkowita	Nie	1	72,9	72,9	10,9	19244	1471	990

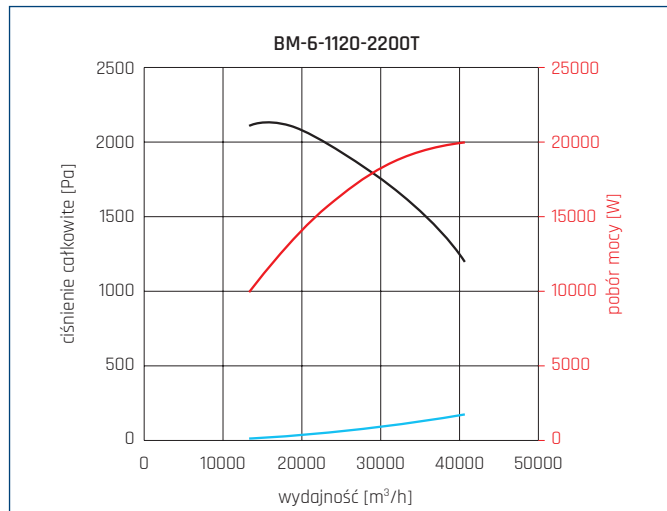

MC	EC	VSD	SR	η[%]	N	[kW]	[m³/h]	[Pa]	[RPM]
B	Całkowita	Nie	1	73,9	73,3	18,9	26915	1850	990

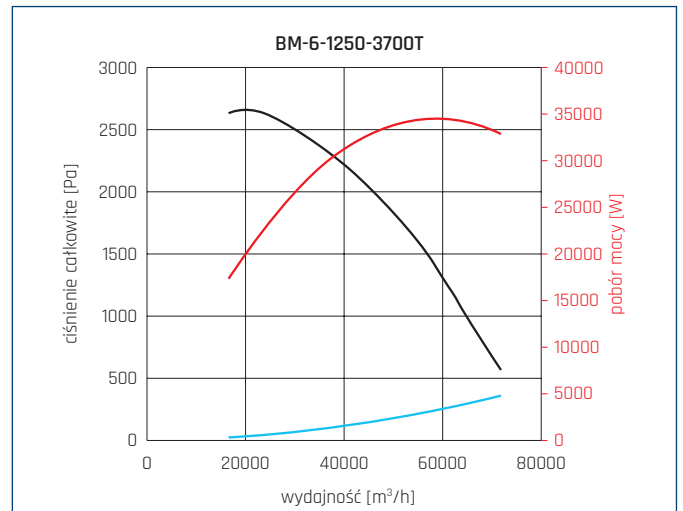

MC	EC	VSD	SR	η[%]	N	[kW]	[m³/h]	[Pa]	[RPM]
B	Całkowita	Nie	1	75	73,8	32,4	37587	2299	990

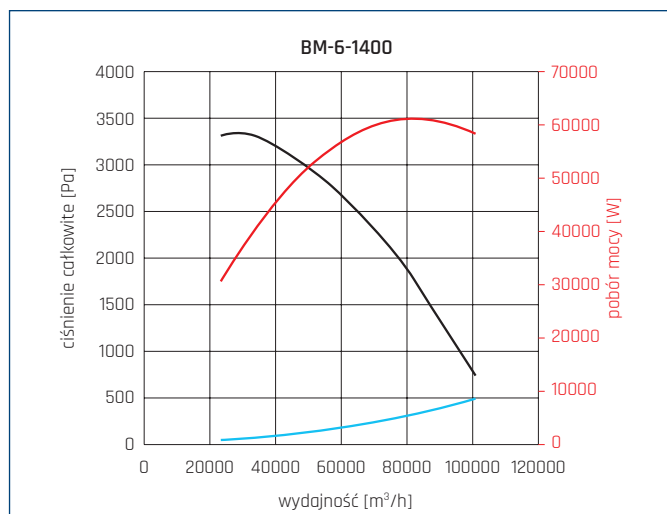

MC	EC	VSD	SR	η[%]	N	[kW]	[m³/h]	[Pa]	[RPM]
B	Całkowita	Nie	1	80,6	52,25	50896	2938	990	

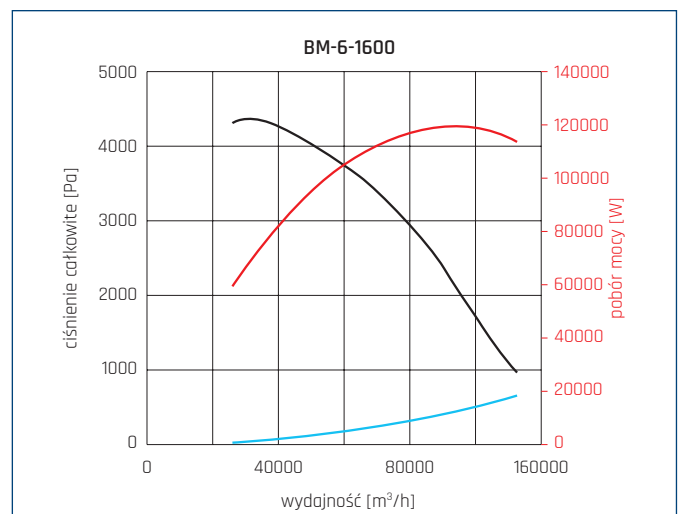

MC	EC	VSD	SR	η[%]	N	[kW]	[m³/h]	[Pa]	[RPM]
B	Całkowita	Nie	1	80,8	101,87	75973	3837	990	

## WYMIARY [mm]

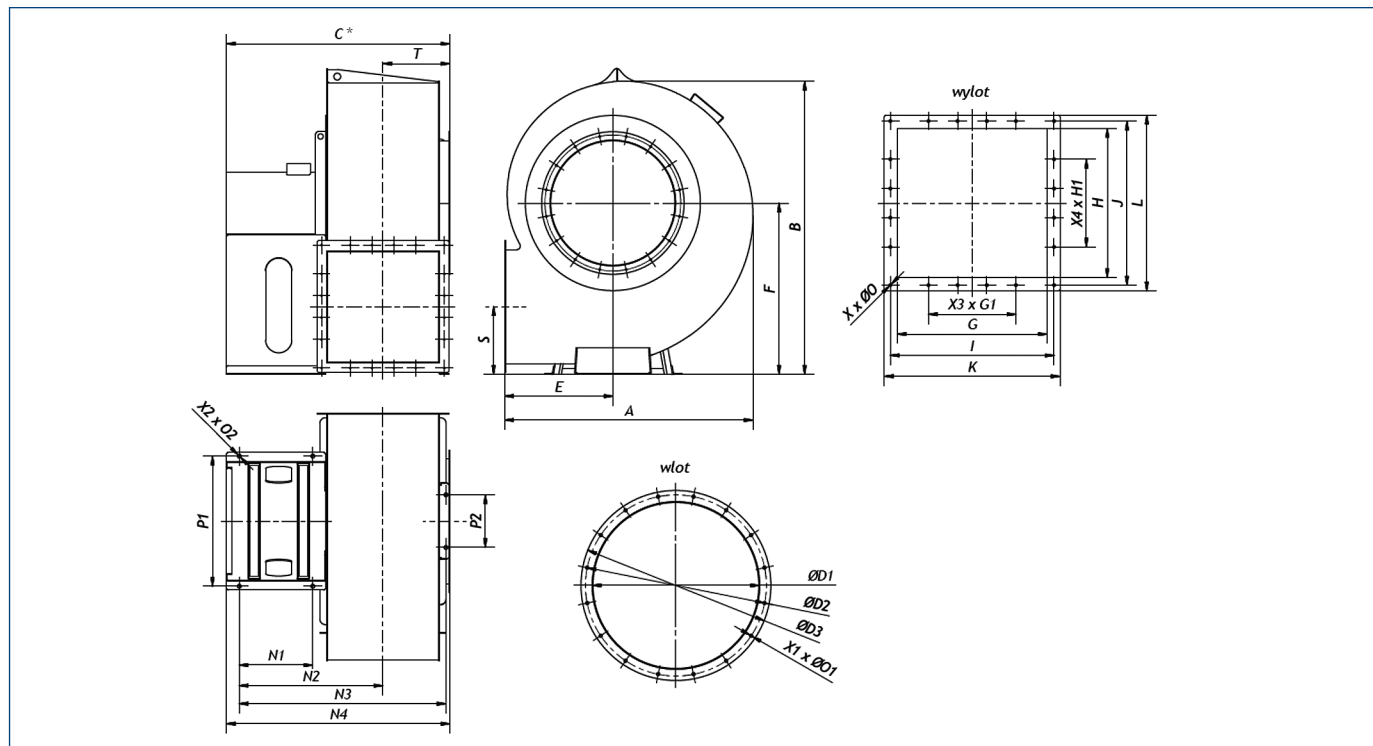

Typ	A	B	C*	E	F	S	T	P1	P2	N1	N2	N3	N4	X2 x Ø2
315	515	623	370	230	375	211	165	350	150	180	137	472	502	6xØ11,5
355	573	702	450	255	425	236	178	400	180	180	165	513	558	6xØ14
400	641	774	470	285	465	264	194	400	180	220	176	579	620	6xØ14
450	723	864	550	319	512	296	222	460	180	240	197	642	689	6xØ14
500	802	961	550	348	566	333	244	500	250	320	226	772	831	6xØ17
560	900	1087	720	392	645	375	266	500	250	370	249	863	925	6xØ17
630	1011	1221	915	441	725	422	291	600	250	420	285	974	1046	6xØ17
710	1123	1325	1000	490	775	469	316	600	250	420	310	1024	1096	6xØ17
800	1256	1511	850	548	895	525	346	670	250	380	350	1054	1136	6xØ17
900	1418	1676	900	618	980	591	382	743	300	420	401	1181	1278	6xØ22
1000	1593	1912	1000	694	1130	666	423	743	300	420	441	1261	1359	6xØ22
1120	1792	2129	1100	781	1250	750	468	743	300	420	486	1351	1449	6xØ22
1250	2016	2378	1240	879	1390	844	518	900	300	420	536	1451	1549	6xØ22
1400	2271	2627	1400	1020	1540	938	568	950	400	450	586	1550	1718	6xØ22
1600	2542	2928	1600	1142	1710	1050	610	1150	400	450	626	1650	1860	6xØ22

Typ	L*	J	H	X4 x H1	K	I	G	X3 x G1	X x Ø0	D1	D3	D2	X1 x Ø01	masa bez silnika
315	286	260	224	-	286	260	224	-	8xØ10	253	323	292	8xØ11,5	32
355	312	286	250	-	312	286	252	-	8xØ10	283	363	332	8xØ11,5	45
400	362	316	280	-	362	316	282	-	8xØ10	318	398	366	8xØ11,5	60
450	397	351	315	1x125	397	351	317	1x125	12xØ10	358	438	405	8xØ11,5	80
500	437	391	355	1x125	437	391	357	1x125	12xØ12	404	484	448	12xØ11,5	120
560	482	436	400	1x125	482	436	402	1x125	12xØ12	454	534	497	12xØ11,5	145
630	532	496	450	3x125	532	496	452	3x125	20xØ12	504	584	551	12xØ11,5	180
710	582	546	500	3x125	582	546	502	3x125	20xØ12	564	664	629	16xØ14	240
800	642	606	560	3x125	642	606	562	3x125	20xØ12	634	734	698	16xØ14	345
900	752	676	630	3x125	752	676	632	3x125	20xØ12	714	814	775	16xØ14	450
1000	832	756	710	5x125	832	756	712	5x125	28xØ12	804	904	869	16xØ12	560
1120	922	846	800	5x125	922	846	802	5x125	28xØ12	904	1004	958	24xØ14	680
1250	1022	946	900	5x125	1022	946	902	5x125	28xØ12	1005	1105	1067	24xØ14	820
1400	1122	1046	1000	7x125	1122	1046	1000	7x125	36xØ12	1125	1245	1200	32xØ18	1100
1600	1242	1192	1122	7x125	1242	1192	1122	7x125	36xØ12	1255	1375	1337	32xØ18	1400

\* -wymiar zależny od rodzaju silnika

\*\*-niektóre wymiary mogą się różnić w zależności od figury wentylatora.

## AKCESORIA MONTAŻOWE

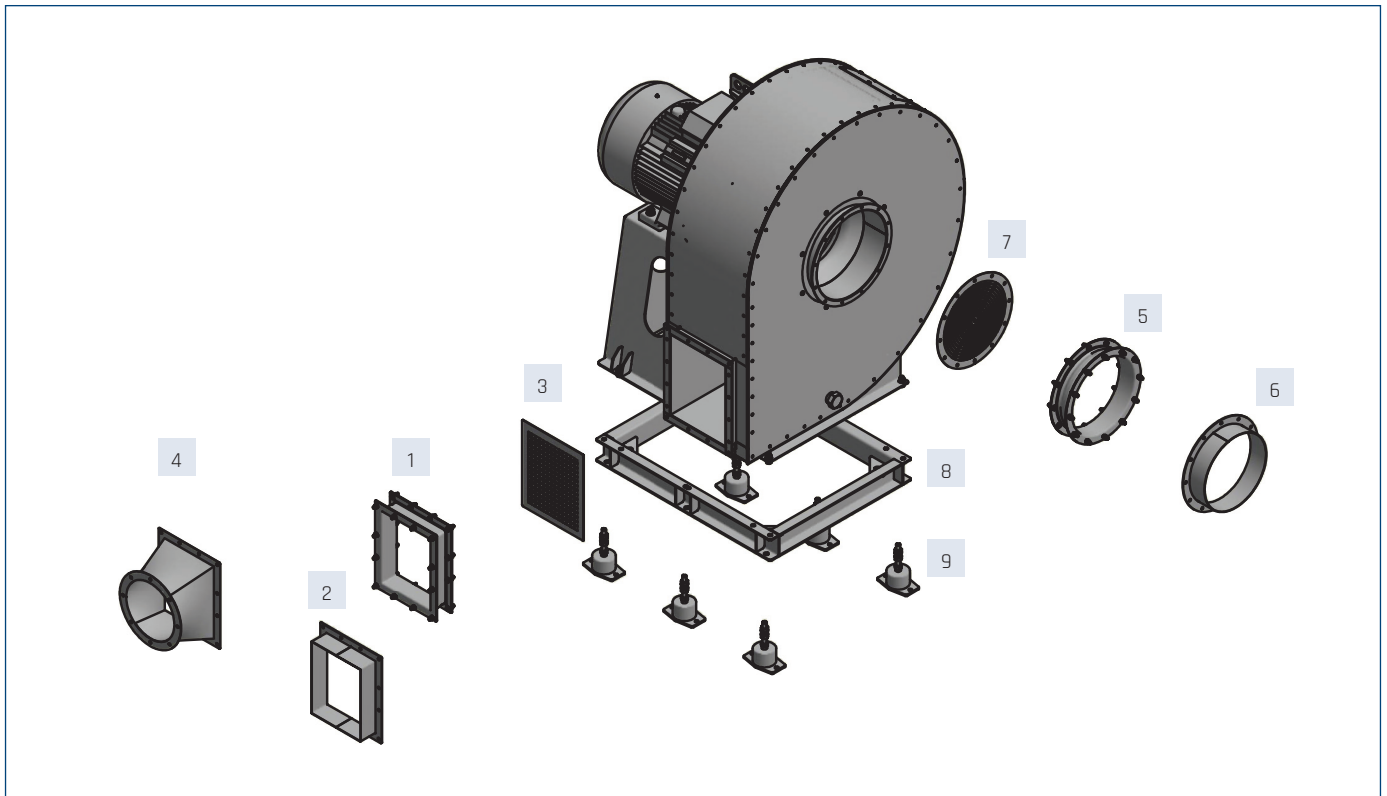

Wentylator	Wylot				Wlot			8
	1	2	3	4	5	6	7	
	Złącze przeciwdrganiowe	Króciec prosty	Ośłona wylotu	Prześciówka	Złącze przeciwdrganiowe	Króciec prosty	Ośłona wlotu	
BM315	40542100	40542300	40542500	40542700	40545130	40545330	40545530	40546100
BM355	40542110	40542310	40542510	40542710	40545140	40545340	40545540	40546110
BM400	40542120	40542320	40542520	40542720	40545150	40545350	40545550	40546120
BM450	40542130	40542330	40542530	40542730	40545160	40545360	40545560	40546130
BM500	40542140	40542340	40542540	40542740	40545170	40545370	40545570	40546140
BM560	40542150	40542350	40542550	40542750	40545180	40545380	40545580	40546150
BM630	40542160	40542360	40542560	40542760	40545190	40545390	40545590	40546160
BM710	40542170	40542370	40542570	40542770	40545200	40545400	40545600	40546170
BM800	40542180	40542380	40542580	40542780	40545210	40545410	40545610	40546180
BM900	40542190	40542390	40542590	40542790	40545220	40545420	40545620	40546190
BM1000	40542200	40542400	40542600	40542800	40545230	40545430	40545630	40546200
BM1120	40542210	40542410	40542610	40542810	40545240	40545440	40545640	40546210
BM1250	40542220	40542420	40542620	40542820	40545250	40545450	40545650	40546220
BM1400	40542230	40542430	40542630	40542830	40545260	40545460	40545660	40546230
BM1600	40542240	40542440	40542640	40542840	40545270	40545470	40545670	40546240

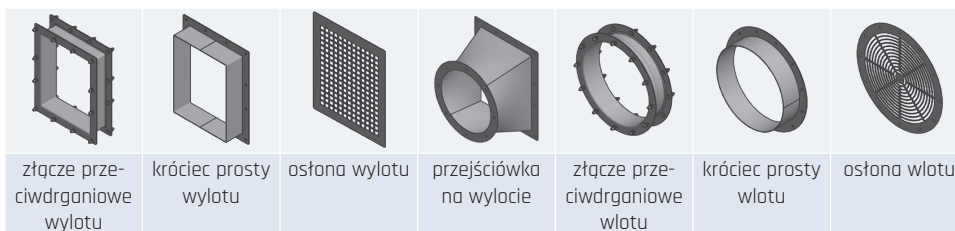



## AKCESORIA ELEKTRYCZNE

Typ	falownik	wyłącznik serwisowy
BM-2-315-110T	L 1,5 kW	R-S 3-F + SP, 10A
BM-2-355-220T	L 2,2 kW	R-S 3-F + SP, 10A
BM-2-400-400T	L 4,0 kW	R-S 3-F + SP, 10A
BM-2-450-750T	L 7,5 kW	R-S 3-F + SP, 16A
BM-2-500-1100T	L 11,0 kW	R-S 3-F + SP, 25A
BM-2-560-1850T	L 18,5kW	R-S 3-F + SP, 40A
BM-2-630-3000T	na zapytanie	na zapytanie
BM-4-315-055T	L 0,75 kW	R-S 3-F + SP, 10A
BM-4-355-055T	L 0,75 kW	R-S 3-F + SP, 10A
BM-4-400-110T	L 0,75 kW	R-S 3-F + SP, 10A
BM-4-450-220T	L 0,75 kW	R-S 3-F + SP, 10A
BM-4-500-220T	L 1,5 kW	R-S 3-F + SP, 10A

Typ	falownik	wyłącznik serwisowy
BM-4-560-220T	L 2,2 kW	R-S 3-F + SP, 10A
BM-4-630-400T	L 4,0 kW	R-S 3-F + SP, 10A
BM-4-710-750T	L 7,5 kW	R-S 3-F + SP, 16A
BM-4-800-1500T	L 15,0 kW	R-S 3-F + SP, 40A
BM-4-900-2200T	L 22,0kW	na zapytanie
BM-6-710-220T	L 2,2 kW	R-S 3-F + SP, 10A
BM-6-800-400T	L 4,0 kW	R-S 3-F + SP, 10A
BM-6-900-750T	L 7,5 kW	R-S 3-F + SP, 16A
BM-6-1000-1500T	L 15,0 kW	R-S 3-F + SP, 40A
BM-6-1120-2200T	L 22,0kW	na zapytanie
BM-6-1250-3700T	na zapytanie	na zapytanie



### Numery artykułów

R-S 3-F + SP, 10A	91040908-01
R-S 3-F + SP, 16A	91040908
R-S 3-F + SP, 25A	91040910
R-S 3-F + SP, 40A	91040924
L 0,75 kW	40016312
L 1,5 kW	40016322
L 2,2 kW	40016332
L 4,0 kW	40016352
L 7,5 kW	40016372
L 11,0 kW	40016383
L 15,0 kW	40016392
L 18,5kW	40016412
L 22,0kW	40016422